

东莞市环昕微实业有限公司

Features

- ▣ IT(RMS): 60A
- ▣ VDRM VRRM:
600V/800V
1200V/1600V/1800V

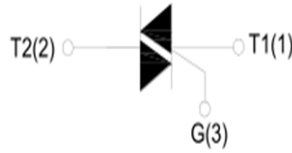

BTA60. PDF

T0-3PS

1 2 3

ABSOLUTE MAXIMUM RATINGS

Symbol	Parameter	Value
I_T (RMS)	RMS on-state current	60A
VDRM	Repetitive peak off-state voltage	600V/800V/1200V/1600V/1800V
VRRM	Repetitive peak reverse voltage	600V/800V/1200V/1600V/1800V
T_j	Operating junction temperature range	$\sim 40^{\circ}\text{C} \sim 125^{\circ}\text{C}$
T_{stg}	Storage junction temperature range	$\sim 40^{\circ}\text{C} \sim 150^{\circ}\text{C}$
VDSM	Non repetitive surge peak Off-state voltage	VDRM+100V
VRSM	Non repetitive peak reverse voltage	VRRM+100V
ITSM	Non repetitive surge peak on-state current (tp=20ms)	550A
$I^2 t$	$I^2 t$ value for fusing (tp=10ms)	1500A ² S
dI/dt	Critical rate of rise of on-state current ($I_G = 2 \times I_{GT}$)	100A/ μ s
IGM	Peak gate current	8A
PG(AV)	Average gate power dissipation	2W
PGM	Peak gate power	10W

ELECTRICAL CHARACTERISTICS ($T_j = 25^{\circ}\text{C}$ unless otherwise specified)

Symbol	Test Condition	Quadrant	Value
			BTA60
IGT	VD=12V RL=33 Ω	I - II - III	< 50mA
VGT		ALL	< 1.3V
VGD	VD=VDRM Tj=125 $^{\circ}\text{C}$ RL=3.3K Ω	ALL	> 0.2V
IL	IG=1.2IGT	I - II - III	< 120mA
IH	IT=100mA		< 80mA
dV/dt	VD=2/3VDRM Gate Open Tj=125 $^{\circ}\text{C}$		> 1500V/ μ s
VTM	ITM=80A tp=380 μ s (Tj =25 $^{\circ}\text{C}$)		< 1.5V
IDRM	VD=VDRMVR=VR	Tj =25 $^{\circ}\text{C}$	< 20 μ A
IRRM	RM	Tj =125 $^{\circ}\text{C}$	< 8mA
Rth(j-c)	junction to case (AC)	T0-3PS	0.5 $^{\circ}\text{C}/\text{W}$

东莞市环昕微实业有限公司

FIG.1 Maximum power dissipation versus RMS on-state current

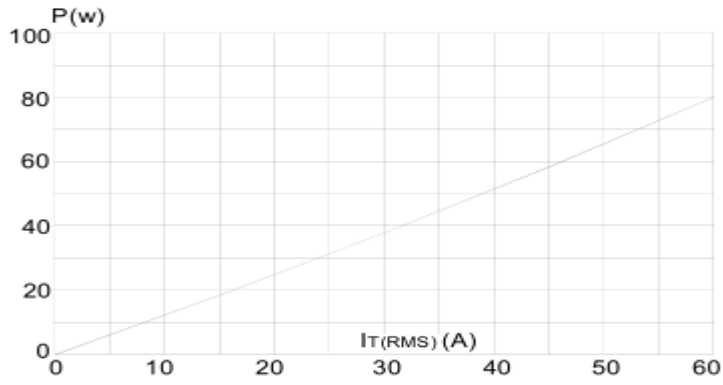

FIG.2: RMS on-state current versus case temperature

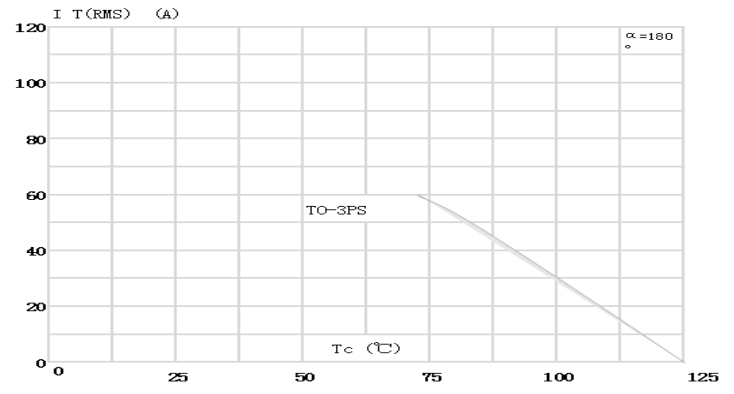

FIG.3: Surge peak on-state current versus number of cycles

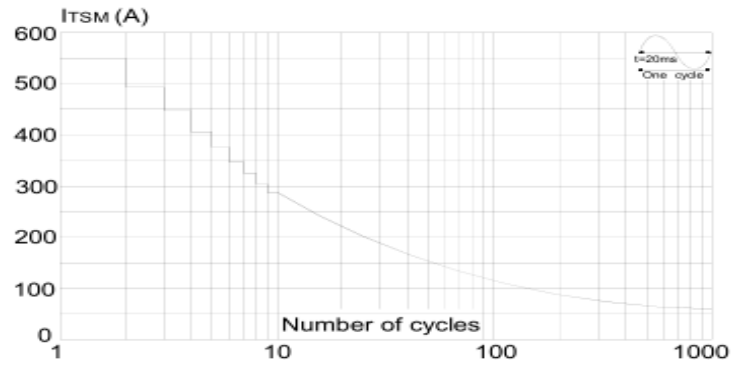

FIG.4: On-state characteristics (maximum values)

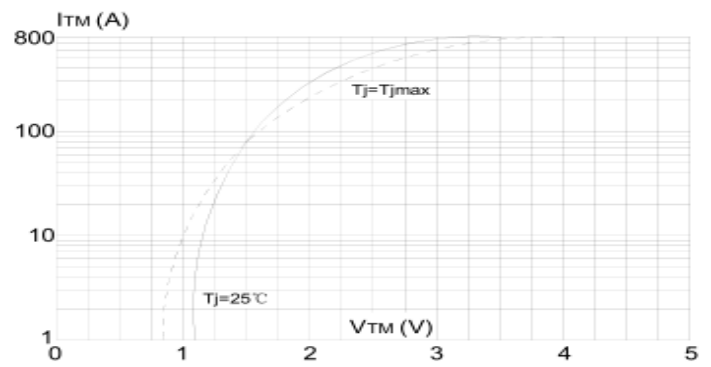

FIG.5: Non-repetitive surge peak on-state current for a sinusoidal pulse with width $t_p < 20\text{ms}$, and corresponding value of I^2t ($dI/dt < 100\text{A}/\mu\text{s}$)

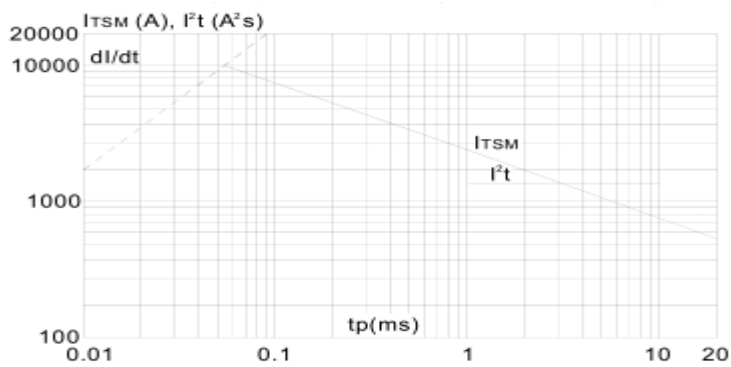
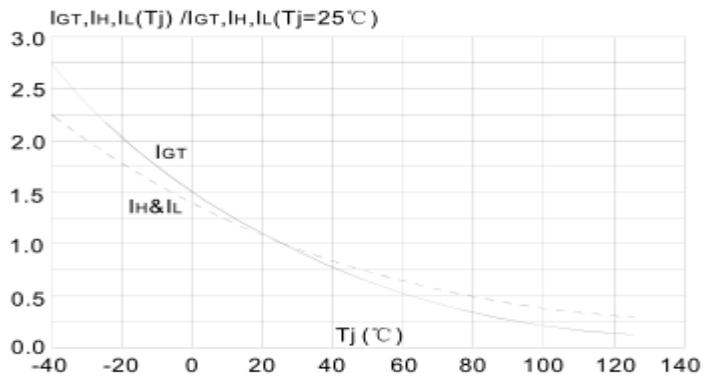
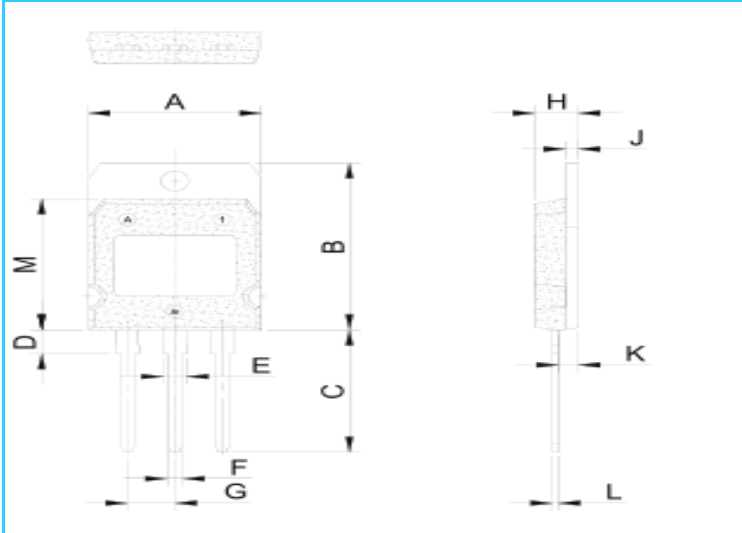

FIG.6: Relative variations of gate trigger current, holding current and latching current versus junction temperature



PACKAGE MECHANICAL DATA



Ref	Dimensions					
	Millimeters			Inches		
	Min.	Typ.	Max.	Min.	Typ.	Max.
A	19.7	19.9	20.1	0.776	0.783	0.791
B	26.9	27.1	27.3	1.059	1.067	1.075
C	19.4	19.9	20.4	0.764	0.783	0.803
D	3.8	3.9	4.0	0.15	0.154	0.157
E	2.56	2.66	2.76	0.101	0.105	0.109
F	1.66	1.76	1.86	0.065	0.069	0.073
G		5.45			0.215	
H	5.05	5.10	5.5	0.199	0.201	0.217
J	1.45	1.50	1.55	0.057	0.059	0.061
K	2.20	2.30	2.40	0.087	0.091	0.094
L	0.60	0.70	0.80	0.024	0.028	0.031
M	21.2	21.3	21.4	0.835	0.839	0.843